

SecuriFire

B5-MIC11 / B6-MIC11

Mounting main indication and control map

B5-MIC711 / B6-MIC711

Main indication and control map

The MIC is available in the following versions:

- B5-MIC11 for SecuriFire 3000
- B6-MIC11 for SecuriFire 1000 and SecuriFire 2000
- B5-MIC711 for SecuriLan redundant
- B6-MIC711 for SecuriLan not redundant



Fig. 1 B5-MIC11 / B6-MIC11 / B5-MIC711 / B6-MIC711

Function/Application

The SecuriFire MIC control panel is for display and operation of the Securiton SecuriFire 1000, SecuriFire 2000 and SecuriFire 3000 fire alarm control panels.

All commands to the system can be initiated from them and all system states are displayed.

The MIC is not language specific; the language is defined in the software (projection via SecuriFire Studio).

Operation

The MIC control panel is operated primarily by means of the SecuriWheel scroll wheel. Thanks to the pictograms, the indication and control map interface is not language specific. Up to four languages can be toggled in the display (320 x 240 pixels) during operation. Please refer to "SecuriFire MIC operating instructions, T811083" for a detailed description of operation.

EPI-Bus

Every MIC has an EPI-BUS (Extended Peripheral Interface). Up to three other devices can be connected to it via an 8-pin RJ-45 plug. The max. bus length is 1 m..

Protocol printer

The internal B5-MIC-PPE protocol printer of the basic configuration is connected to a MIC11 using a 16-pin ribbon cable connector.

The external B5-MIC-PPE protocol printer is connected to an MIC711 using a 16-pin ribbon cable connector and has to be mounted in the immediate vicinity of the control panel.

MIC11

The mounting main indication and control map MIC11 is mounted in the door of the SecuriFire SCP. Connection to the system is by means of a ribbon cable to the B5-MCB15 main control board or to the main processing unit B6-BCB12 / B6-BCB13.

In contrast to the B6-MIC11, the B5-MIC11 is designed to be redundant.



Fig. 2 B5-MIC11 / B6-MIC11

MIC711

The MIC711 main indication and control map consists of the MIC711 and MIC485 modules and can be connected as a participant directly in the SecuriLan via RS485 or Ethernet. Though the topology can be freely selected, a simple or redundant loop connection is recommended.

The MIC711 must be supplied with 24 VDC redundant power from the SecuriFire control panel.

For service purposes (e.g. loading software and projection data, and for system diagnostics) an accessible RJ-45 Ethernet interface outside the map case is available.

An SD card slot on the MIC711 (min. 1 SD card in SecuriLan) is available for increasing the event memory up to 65,000 events.

In contrast to the B6-MIC711, the B5-MIC711 is designed to be redundant.



Fig. 3 B5-MIC711 / B6-MIC711

B5-MIC11 / B6-MIC11

Interfaces MIC11

- X1** Connection to B5-MCB15 (B5-MIC11)
Connection to B6-BCB12 / B6-BCB13 (B6-MIC11)
- X2** Display connection (rear side)
- X3** Jumper of indication and control map audible
- X6** EPI-Bus
- X7** B5-MIC-PPE protocol printer connection

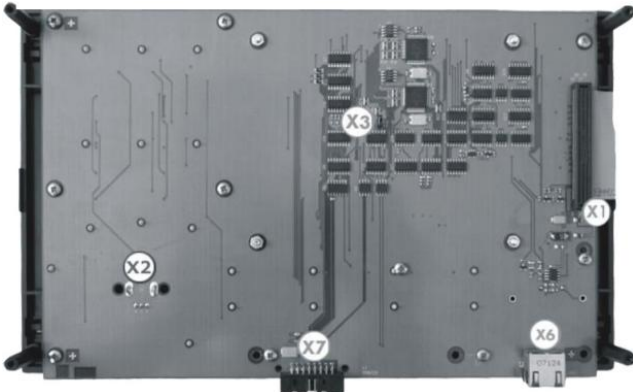

Fig. 4 Rear side of B5-MIC11



Fig. 5 Front side of MIC11

Indication and control map audible (X3)

	Audible switched on
	Audible switched off

EPI-BUS (X6)

Terminal	Description	Terminal	Description
1	GNDP	5	+3V3
2	VP	6	+3V3
3	EXTBUS+	7	GND
4	EXTBUS-	8	GND

Technical data

Electrical	RS485
Coverage	max. 1 m
Transmission type	asynchronous, serial, 9,6kbit/s
Direction	bidirectional, half-duplex
Mechanical design	RJ-45, 8-pin

Expansion or replacement of the MIC11

 Before working on the control panel, you must de-energise it.

1. Open map case door and unplug the ribbon cable from the B5-MCB15 (SCP3000), B6-BCB13 (SCP2000) or B6-BCB12 (SCP1000).
2. Remove covers on both sides. Insert a screwdriver into the slit and lightly press to release the lock.
3. Unlock all four screws and lift up the control panel to the front.
4. Unplug the ribbon cable from the protocol printer.
5. If an EPI device is connected, the RJ45 plug must be disconnected.



Fig. 6 SCP 3000 with B5-MIC11



Fig. 7 SCP 2000 with B6-MIC11

B5-MIC711 / B6-MIC711

Interfaces MIC711

- X2** Display connection (rear side)
- X3** Service interface Ethernet 100BASE-TX
- X9** SD card slot
- X10** Jumper of indication and control map audible
- X100** Interface MIC711 - MIC485

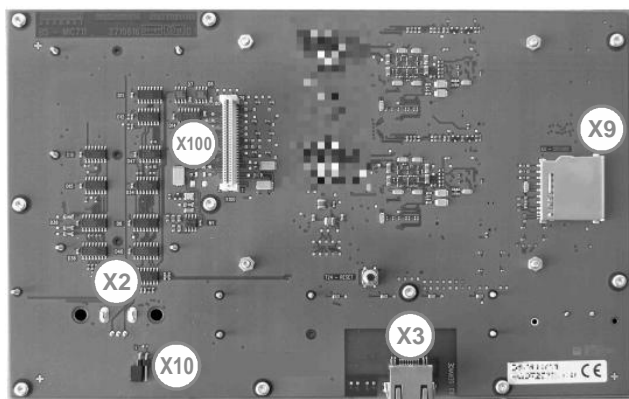

Fig. 8 Rear side of B5-MIC711

Ethernet 10/100BASE-TX service interface (X3)

Terminal	Description
A1	TX+
A2	TX-
A3	RX+
A4	Termination
A5	Termination
A6	RX-
A7	Termination
A8	Termination

Technical data

Electrical	Service PC, Ethernet 100BASE-TX
Coverage	max. 100 m
Transmission type	TCP/IP, max. 100 Mbit/s
Direction	bidirectional, full-duplex operation
Mechanical design	RJ-45, 8-pin

Indication and control map audible (X10)

	Audible switched on
	Audible switched off

Interfaces B5-MIC485 network module interfaces

- X1** Power supply connection
- X2** EPI-Bus
- X3** 10/100BASE-TX network connection
- X4** RS485 network connection
- X7** B5-MIC-PPE protocol printer connection
- X100** Interface MIC485 - MIC711

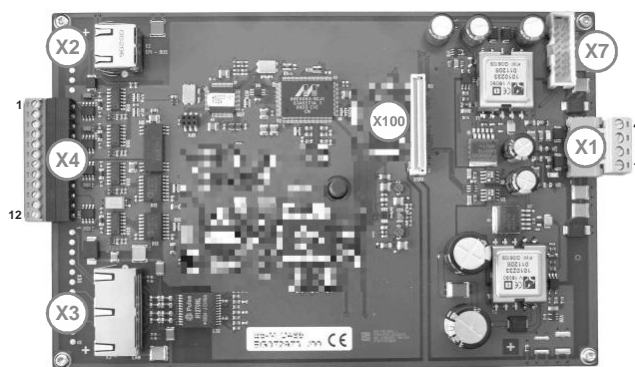

Fig. 9 Rear side of B5-MIC485 network module

Power supply connection plug (X1)

Terminal	Description
1	Positive connection A +26V =
2	Negative connection A GND
3	Positive connection B +26V =
4	Negative connection B GND

Technical data

Connection	SecuriFire SCP power supply
Voltage	26 V DC
Current	200 mA
Coverage	max. 1200 m
Mechanical design	plug-in screw terminal, max. 2.5 mm ²

EPI-BUS (X2)

Terminal	Description	Terminal	Description
1	GNDP	5	+3V3
2	VP	6	+3V3
3	EXTBUS+	7	GND
4	EXTBUS-	8	GND

Technical data

Electrical	RS485
Coverage	max. 1 m
Transmission type	asynchronous, serial, 9,6kbit/s
Direction	bidirectional, half-duplex
Mechanical design	RJ-45, 8-pol.

Data sheet

10/100BASE-TX network connection (X3)

Port 0 of switch A and port 0 of switch B

Terminal	Description	Terminal	Description
1	RX+	5	Termination
2	RX-	6	TX-
3	TX+	7	Termination
4	Termination	8	Termination

Technical data

Electrical	Ethernet 100BASE-TX
Coverage	max. 100 m
Transmission type	TCP/IP, max. 100 Mbit/s
Direction	bidirectional, full-duplex operation
Mechanical design	double RJ-45 connector, 8-pin

RS485 network connection (X4)

Terminal	Description	
	B5-MIC485	B6-MIC485
1	Port 6B X TX/RX+	Port 6A X TX/RX+
2	GND	GND
3	Port 6B X TX/RX-	Port 6A X TX/RX-
4	Port 6B Y TX/RX+	Port 6A Y TX/RX+
5	GND	GND
6	Port 6B Y TX/RX-	Port 6A Y TX/RX-
7 ¹⁾	Port 6A X TX/RX+	Port 5A X TX/RX+
8	GND	GND
9 ¹⁾	Port 6A X TX/RX-	Port 5A X TX/RX-
10 ¹⁾	Port 6A Y TX/RX+	Port 5A Y TX/RX+
11	GND	GND
12 ¹⁾	Port 6A Y TX/RX-	Port 5A Y TX/RX-

¹⁾ galvanically isolated

Technical data

Connection	SecuriLan
Electrical	High Speed RS485
Transmission type	asynchronous, serial, 675/1,250 kBaud
Direction	bidirectional, half-duplex
Cable	CAT 5
Coverage	max. 1200 m
Mechanical design	plug-in screw terminal, max. 1.5mm ²

Mounting

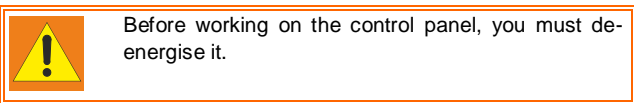

1. Remove covers on both sides. Insert a screwdriver into the slit and lightly press to release the lock.
2. Unlock all four screws and lift up the control panel to the front.
3. Holes for the required cable entries can be broken out on top, bottom, right, left or on the rear side of the map case. Cable strain relief is possible by means of holders for cable fasteners in the rear wall of the map case.



Fig. 10 Front side of MIC711

Connection example

Additional information for connecting the MIC711 in the SecuriLan can be found in the following documents:

- T811123 SecuriFire LAN network boards and units
- T811044 SecuriFire 3000 Mounting and Installation
- T811086 SecuriFire 1000/2000 Mounting and Installation

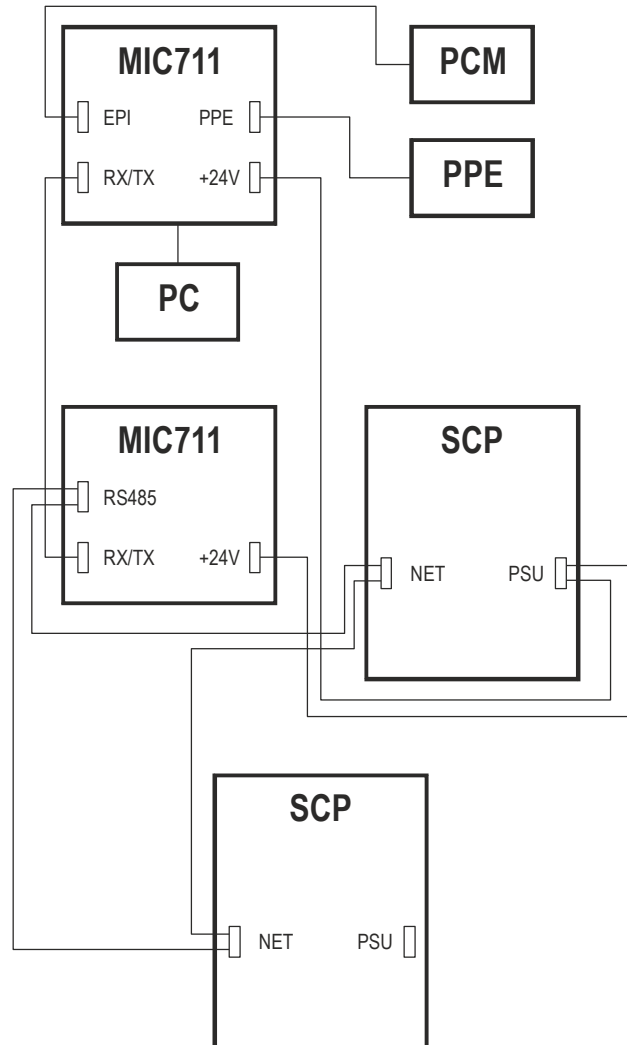

Fig. 11 connection example MIC711

Dimensioned drawing

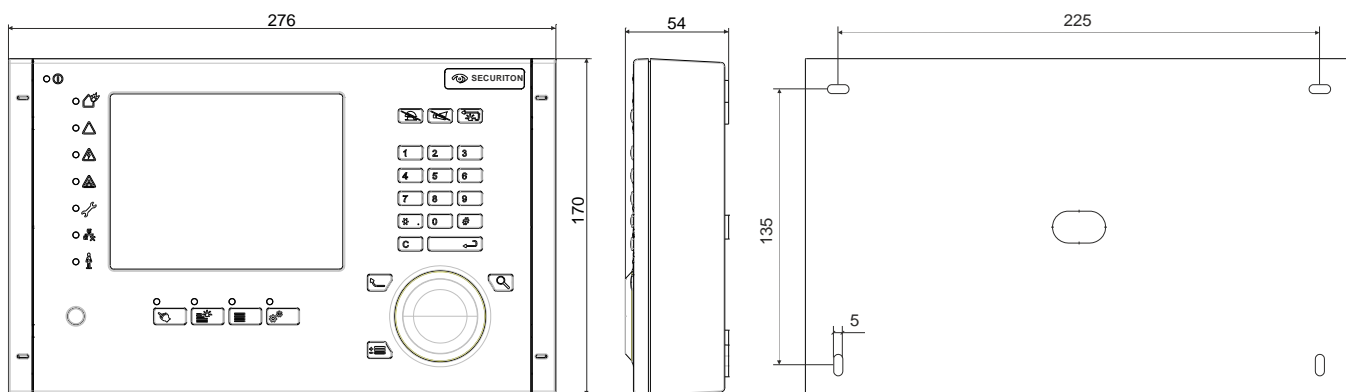

Fig. 12 Dimensioned drawing MIC711

Programming and planning

Information about programming, please refer to the SecuriFire Studio manual T811093.

MIC711

- Up to 31 MIC711s can be connected together with other SCPs on a SecuriLan.
- The maximum number of MIC711s and SCPs on a SecuriLan is limited to 32.
- The maximum line length between two neighbouring SecuriLan devices is 1,200 metres.

MIC11

- The MIC711 is counted as 1 of max. 16 control panels (per SCP).

Indication and operation elements



Fig. 13 User interface

- (1) Operation LED
- (2) Fire alarm LED
- (3) General fault LED
- (4) Energy fault LED (mains, battery)
- (5) System fault LED
- (6) Maintenance LED
- (7) Deactivations LED
- (8) Delay LED
- (9) Operation key
- (10) Alarm list key
- (11) Event list key
- (12) Configuration key
- (13) Multiple selection key
- (14) Previous key
- (15) Help key
- (16) SecuriWheel
- (17) Clear key
- (18) Enter key
- (19) Separator key
- (20) Discard code key
- (21) Numerical keypad
- (22) Reset buzzer key
- (23) Reset alarm units key
- (24) Reset system / alarm
- (25) Display

Data sheet

Article numbers / spare parts

Short designation	Art. number CH	Art. number
B5-MIC11 Mounting main indication and control map	019.614 726	EG054500
B5-MIC711 Main indication and control map	019.239 550	FG054510
B6-MIC11 Mounting main indication and control map	019.616 141	FG054501
B6-MIC711 Main indication and control map	019.246 271	20-1230003-01-01
SD-CARD SD card	038.614 645	FG020325
Jumper	239.134 287	--
COS 701-1 Covering strip (2 pces)	019.247 874	12-4400051-01-01

Technical data

Supply voltage	+22 V to +30 V DC
Ascent current consumption	
B5-MIC11	typ. 29,5 mA
B5-MIC711	typ. 213 mA
B6-MIC11	typ. 24 mA
B6-MIC711	typ. 165 mA
Protection type MIC11 / MIC711	IP00 / IP42
Ambient temperature	-5 °C to +50 °C
Relative humidity	5 % to 95 %, without condensation
Air pressure	≥ 80 kPa, up to 2'000 m above sea level
Dimensions MIC711 (L x W x D)	276 x 170 x 54 mm
Housing	ABS anthracite grey RAL 7016
Weight (gross/net)	
B5-MIC11, B6-MIC11	960/710 g
B5-MIC711, B6-MIC711	1445/1190 g